

PN-16

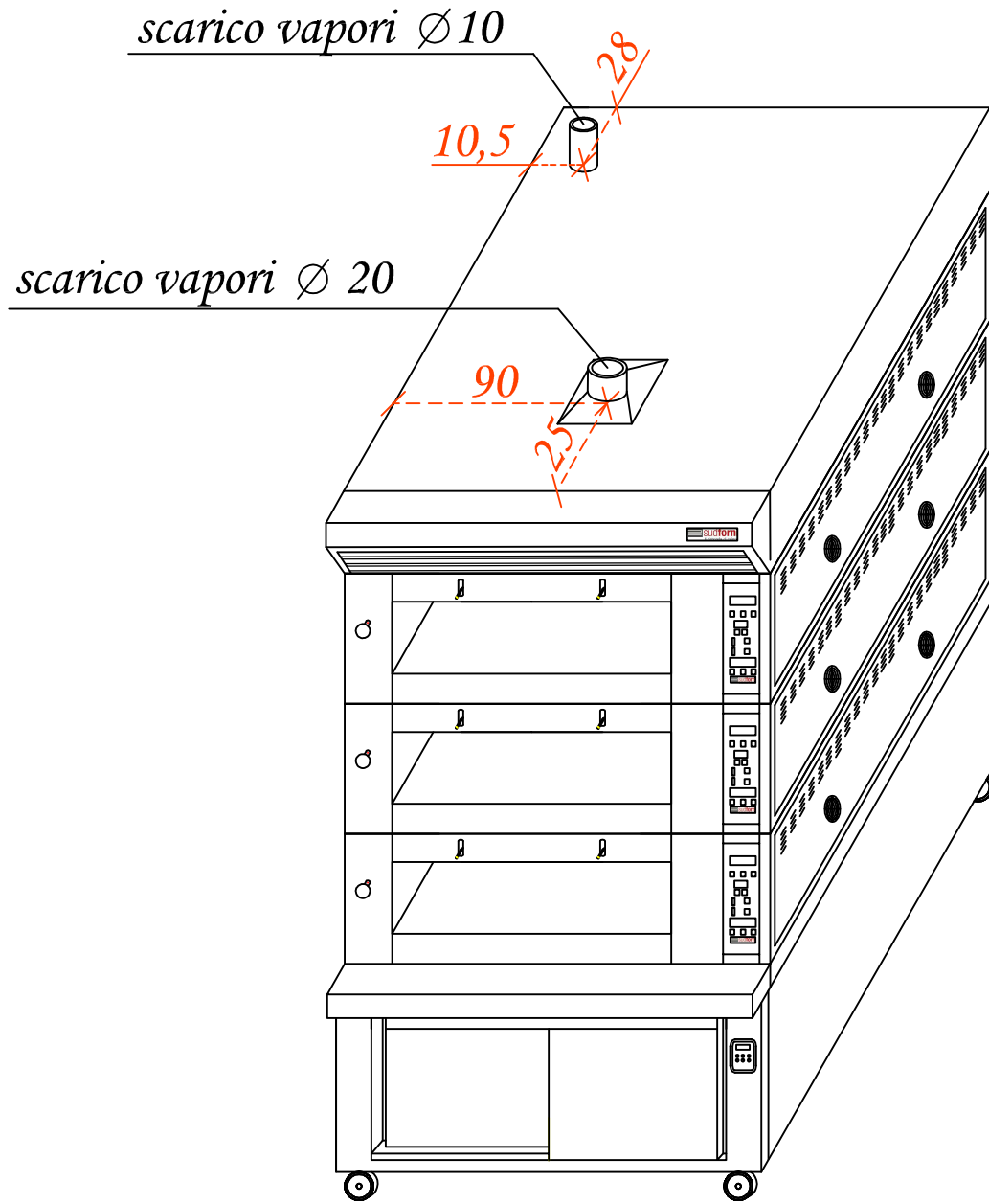

Vista frontale

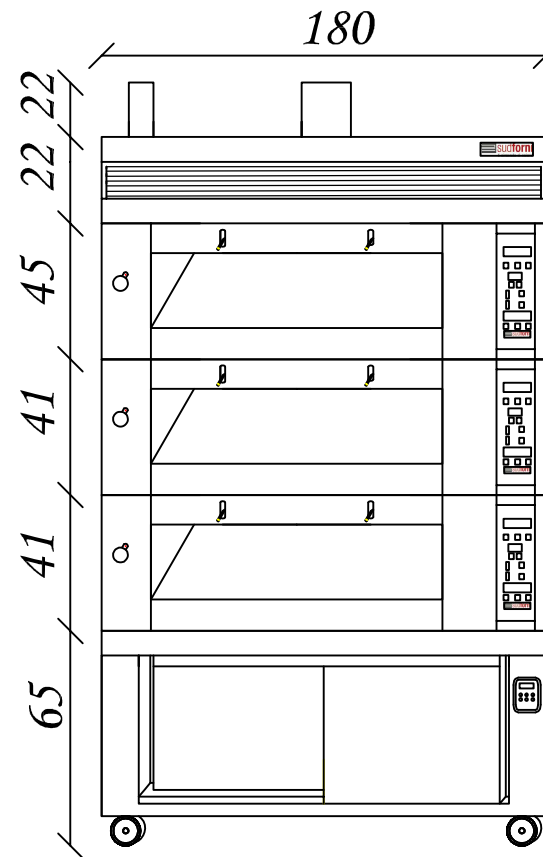

Vista laterale

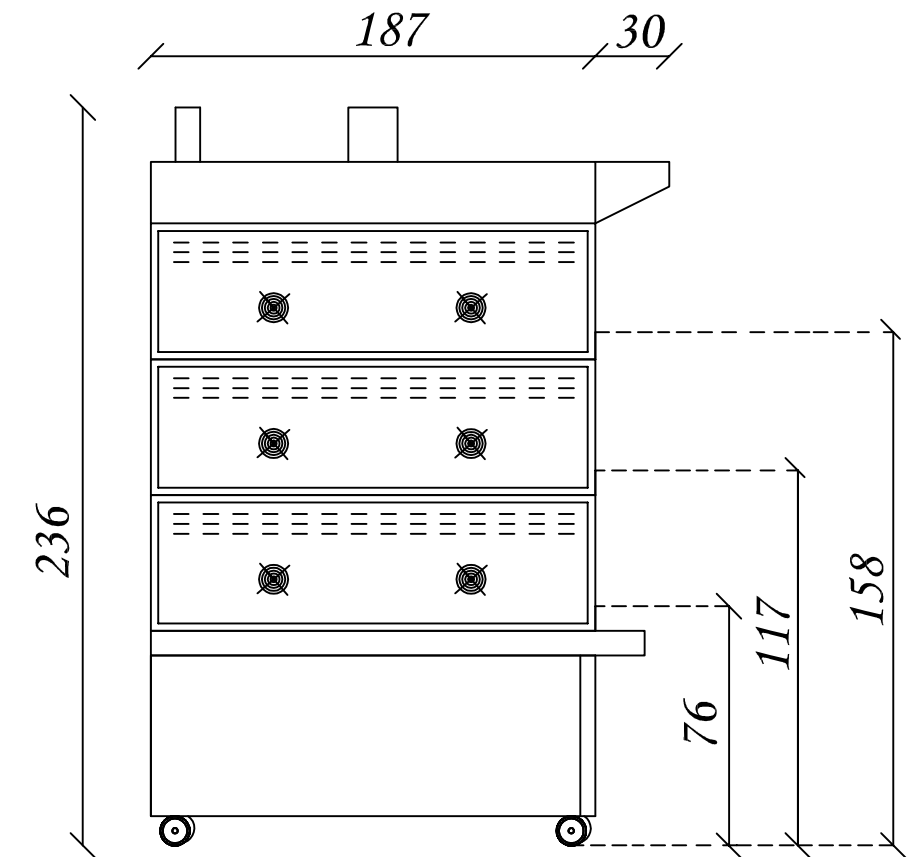

Misure espresse: cm	Modello Componibile: 3 Camere PN-16
Data elaborazione: 12/6/2017	Alimentazione: 400V/3 +N
Disegnato da: Leonardo Piccolo	Potenza max assorbita/h: 13 kw cad.
 sudforni ti circonda di calore	Cavo alimentazione: H07 RN-F